

OpenAir™

GCA Series Spring Return 142 lb-in Electronic Damper Actuators



Description The OpenAir 24 Vac/dc spring return 142 lb-in electronic actuator is designed for digital or analog control of building HVAC dampers.

- Features**
- Brushless DC motor technology with stall protection
 - Bi-directional fail-safe spring return
 - Patented self-centering shaft coupling
 - Manual override
 - 142 lb-in (16 Nm) torque
 - 5° preload as shipped from factory
 - Offset and span adjustment models available
 - Models with independently adjustable dual auxiliary switches available
 - UL and cUL listed



Application These actuators are designed for use in constant or variable air volume installations for the control of return air, mixed air, exhaust, and face and bypass dampers requiring up to 142 lb-in (16 Nm) torque. They are designed for applications that require the damper to return to a fail-safe position when there is a power failure.

Product Numbers

Table 1.

| Product Number | Operating Voltage | | | Control | | | | Cables | | Built-in Control Options | | | |
|----------------|-------------------|--------------|---------------|-------------|----------------------------|------------|------------|----------|--------|--------------------------|-------------------------|------------------|---------------------------------------|
| | 24 Vac ± 20% | 24 Vdc ± 10% | 120 Vac ± 10% | 0 to 10 Vdc | 2 to 10 Vdc or 0 to 10 Vdc | 3-position | 2-position | Standard | Plenum | Position Feedback | Dual Auxiliary Switches | Signal Inversion | Offset 0 to 5 Vdc Span 2 to 30 Vdc |
| GCA121.1U | • | • | | | | | • | • | | | | | |
| GCA121.1P | • | • | | | | | • | | • | | | | |
| GCA126.1U | • | • | | | | | • | • | | | • | | |
| GCA126.1P | • | • | | | | | • | | • | | • | | |
| GCA221.1U | | | • | | | | • | • | | | | | |
| GCA226.1U | | | • | | | | • | • | | | • | | |
| GCA131.1U | • | • | | | | • | | • | | | | | |
| GCA131.1P | • | • | | | | • | | | • | | | | |
| GCA132.1U | • | • | | | | • | | | • | • | | | |
| GCA132.1P | • | • | | | | • | | • | | • | | | |
| GCA136.1U | • | • | | | | • | | | • | | • | | |
| GCA136.1P | • | • | | | | • | | • | | | • | | |
| GCA151.1U | • | • | | | | | | • | | • | | • | |
| GCA151.1P | • | • | | | | | | | • | • | | • | |
| GCA156.1U | • | • | | | | | | • | | • | • | • | |
| GCA156.1P | • | • | | | | | | | • | • | • | • | |
| GCA161.1U | • | • | | • | | | | • | | • | | | |
| GCA161.1P | • | • | | • | | | | | • | • | | | |
| GCA163.1U | • | • | | • | | | | • | | • | | | • |
| GCA163.1P | • | • | | • | | | | | • | • | | | • |
| GCA164.1U | • | • | | • | | | | • | | • | • | | • |
| GCA164.1P | • | • | | • | | | | | • | • | • | | • |
| GCA166.1U | • | • | | • | | | | • | | • | • | | |
| GCA166.1P | • | • | | • | | | | | • | • | • | | |

Warning/Caution Notations

| | | |
|-----------------|---|--|
| WARNING: |  | Personal injury/loss of life may occur if you do not perform a procedure as specified. |
| CAUTION: |  | Equipment damage may occur if you do not follow a procedure as specified. |

Specifications

| | | |
|-----------------------------|-----------------------------------|--|
| Ambient conditions | Ambient temperature operation | -25°F to 130°F (-32°C to 55°C) |
| | storage and transport | -40°F to 158°F (-40°C to 70°C) |
| | Ambient humidity (non-condensing) | 95% rh |
| Agency certification | | UL listed to UL60730 (to replace UL873) |
| | | cUL certified to Canadian Standard C22.2 No. 24-93 |

| Power Supply | | <u>GCA16x</u> | <u>GCA15x</u> | <u>GCA13x</u> | <u>GCA12x</u> | <u>GCA22x</u> |
|--|---|---|--|---------------|----------------------------------|------------------------------------|
| Operating Voltage (G-G0) | 24 Vac ± 20% | 24 Vac ± 20% | 24 Vac ± 20% | 24 Vac ± 20% | 24 Vac ± 20% | 120 Vac ± 10% |
| | 24 Vdc ± 10% | 24 Vdc ± 10% | 24 Vdc ± 10% | 24 Vdc ± 10% | 24 Vdc ± 10% | — |
| Frequency | 50/60 Hz | 50/60 Hz | 50/60 Hz | 50/60 Hz | 50/60 Hz | 50/60 Hz |
| Power Consumption | running | 9 VA/7W | 9 VA/7W | 8 VA/6W | 8 VA/6W | 9 VA |
| | holding | 5 VA/7W | 5 VA/4W | 5 VA/4W | 3 VA/3W | 9 VA |
| Control Signal | | <u>GCA16x</u> | <u>GCA15x</u> | <u>GCA13x</u> | <u>GCA12x</u> | <u>GCA22x</u> |
| Input Signal (Y-G0) voltage input | 0 to 10 Vdc (max. 35 Vdc) | 0 to 10 Vdc or 2 to 10 Vdc (max. 35 Vdc) | 3-Position | 2-Position | 2-Position | — |
| | input resistance | >100K ohms | >100K ohms | — | — | — |
| Feedback Signal | | <u>GCA16x</u> | <u>GCA15x</u> | <u>GCA13x</u> | <u>GCA12x</u> | <u>GCA22x</u> |
| Position output signal (U-G0) voltage output | 0 to 10 Vdc | 0 to 10 Vdc | 0 to 1000 ohms , <10 Ma (GCA 132x only) Load <1W | — | — | — |
| | maximum output current | ±1 mA | +1 mA, -.5 mA | — | — | — |
| Function | Running/spring return torque | | | | | |
| | Operating with 24 Vac | | | | 142 lb-in (16 Nm) | |
| | Maximum torque | | | | <360 lb-in (40 Nm) | |
| | Runtime for 90° operating with motor closing (on power loss) with spring return | | | | 90 seconds 15 seconds typical | |
| Equipment rating | | | | | | Class 2, in accordance with UL/CSA |
| Mounting | Nominal angle of rotation | 90° | | | | |
| | Maximum angular rotation | 95° | | | | |
| | Shaft size | 3/8-inch to 1-inch (8 mm to 25.6 mm) dia. 1/4-inch to 5/8-inch (6 to 18 mm) square | | | | |
| | Minimum shaft length | 3/4-inch (20 mm) | | | | |

| | | |
|----------------------------------|-----------------------------------|--|
| Specifications, continued | Control signal adjustment | |
| | Offset (start point) | Between 0 Vdc to 5 Vdc |
| Auxiliary features | Factory setting | 0 Vdc |
| | Span | Between 2 Vdc to 30 Vdc |
| Dual auxiliary switches | | |
| | AC rating (Standard cable) | 24 Vac to 250 Vac AC 6A resistive AC 2A FLA, 12LRA |
| | AC rating (Plenum cable) | 24 Vac AC 4A resistive AC 2A, FLA, 12 LRA |
| | DC rating (Standard/Plenum cable) | 12 Vdc to 30 Vdc DC 2A |
| | Switch Range | |
| | Switch A | 0 to 90° with 5° intervals |
| | Recommended range usage | 0 to 45° |
| | Factory setting | 5° |
| | Switch B | 0 to 90° with 5° intervals |
| | Recommended range usage | 45° to 90° |
| | Factory setting | 85° |
| | Switching hysteresis | 2° |



WARNING:

Apply only AC-line voltage from the same phase or only UL-Class 2 voltage to the switching outputs of both auxiliary switches A and B. Mixed operation is not permissible.

NOTE: With plenum cables, only UL-Class 2 voltage is permitted.

| | | |
|----------------------------------|------------------------------|--|
| Specifications, continued | Enclosure | NEMA 2 in vertical to horizontal 90° See Figure 17. |
| | | NEMA 3R rated when installed with ASK75.1U Weather Shield in the vertical position. See Figure 18. See <i>Accessories</i> , Figure 9. |
| Housing | Material Gear lubrication | Die cast aluminum alloy Silicone-free |
| Miscellaneous | Pre-cabled connection | 18 AWG |
| | Cable length | 3 feet (0.9 m) |
| | Noise level | <45 dBA (running) |
| | Life cycle | Designed for over 60,000 full strokes and a minimum of 1.5 million repositions at rated torque and temperature. |
| | Dimensions Weight | See Figure 29. 4.85 lb (2.2 kg) |

Actuator Components

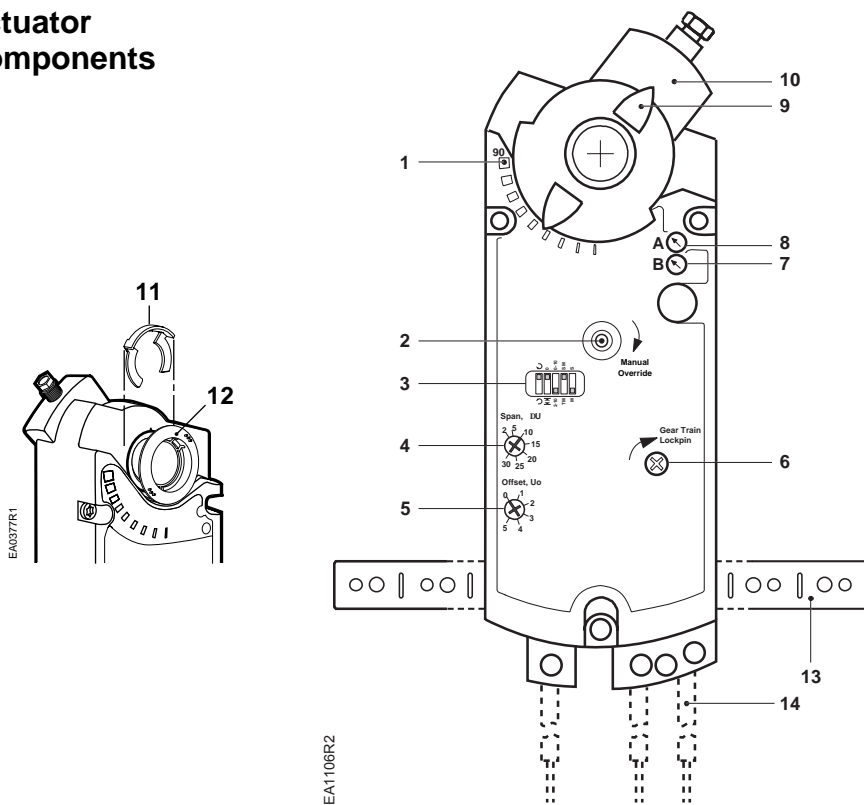

Legend

1. Positioning scale for angle of rotation
2. Manual override wrench opening and direction of rotation arrow
3. DIP switches
4. Span adjustment
5. Offset (start point) adjustment
6. Gear train lock pin
7. Auxiliary switch B
8. Auxiliary switch A
9. Position indicator
10. Self-centering shaft adapter
11. Shaft adapter locking clip
12. Position indicator adapter
13. Mounting bracket
14. Connection cables

Figure 1. Modulating GCA Actuator.

NOTE: Not all features are on all models.
 See Table 1 for a listing of features per model.

Accessories

NOTE: The control signal adjustment cannot be added in the field. Order the product number that includes the option(s).

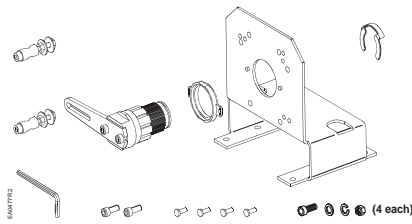

Figure 2. Floor Mount Kit.

ASK71.1U: Allows foot mounting of OpenAir actuators. Should be used for in-the-air stream applications, and generally, anywhere a foot-mounted actuator can be mounted. Kit contains:

- Crank arm for changing angular rotation into a linear stroke.
- Support bearing ring to minimize side loading on the actuator's output bearing.
- Mounting bracket.
- Required mounting fasteners.

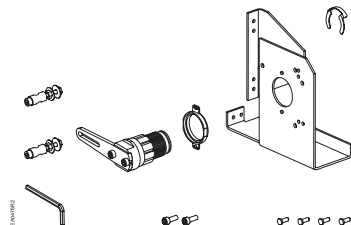

Figure 3. Frame Mount Kit.

ASK71.2U: Allows mounting OpenAir actuators directly to damper frame. Should be used with louvers and vents and in applications where floor mount kit is not possible. Kit contains:

- Crank arm for changing angular rotation into a linear stroke.
- Support bearing ring to minimize side loading on the actuator's output bearing.
- Mounting bracket.
- Required mounting fasteners.



Figure 4. Crank Arm Kit.

ASK71.3: Allows direct-coupled actuator to provide an auxiliary linear drive. Crank arm kit can be used to simultaneously drive a set of opposing or adjacent dampers with single actuator. Kit includes:

- Crank arm to attach to the splined hub of the shaft adapter.
- Other required mounting fasteners.

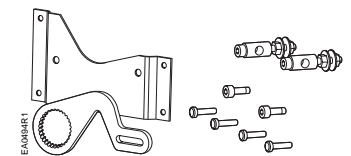

Figure 5. Crank Arm Kit with Mounting Bracket.

ASK71.4: Allows economical mounting of OpenAir actuator to a variety of surfaces. Kit should be used in applications where the actuator can be rigid-surface mounted and linear stroke output is required. Kit includes:

- Crank arm to attach to the splined hub of the shaft adapter.
- Mounting bracket.
- Other required mounting fasteners.

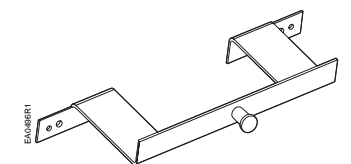

Figure 6. Tandem Mount Bracket.

ASK73.1: Bracket provides an extended anti-rotation pin allowing two OpenAir actuators to directly drive a single damper shaft.

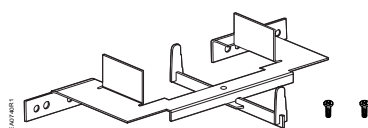

Figure 7. Tandem Mount Bracket.

ASK73.2U: Bracket provides an extended anti-rotation pin allowing two OpenAir modulating actuator to directly drive a single damper shaft. (For GCA 16x Series only.)

**Accessories,
 Continued**

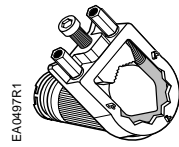

Figure 8. Special Shaft Adapter.

ASK74.1U: Shaft adapter will attach to a 1.05-inch (26.6 mm) diameter shaft; the standard self-centering adapter will accept up to a one-inch (25.4 mm) diameter shaft.

- Adapter can be used for coupling to slightly oversized one-inch (25.4 mm) jackshafts.
- Shaft adapter is 13/16-inches (20 mm) shorter than the height of the self-centering shaft adapter.

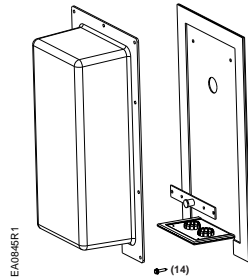

Figure 9. Weather Shield.

ASK75.1U: GCA actuators are UL listed to meet NEMA 3R requirements (a degree of protection against rain, sleet, and damage from external ice formation) when installed with ASK75.1U Weather Shield and outdoor-rated conduit fittings in the vertical position.

For dimensions, see Figure 28.

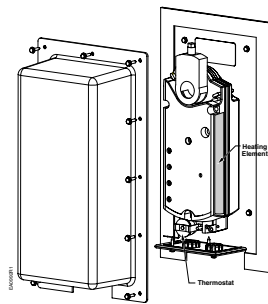

Figure 10. Heater/Weather Shield Assembly.

985-106: Provides protection for GIB, GBB and GCA OpenAir actuators down to temperatures of -58°F (-50°C). Assembly includes:

- Weather Shield
- Heater Kit



**Figure 11.
 499 Ohm Resistor Assembly Kit.**

985-124: Used for converting a 4 to 20 mA controller output signal into a 2 to 10 Vdc actuator signal.

Service Parts

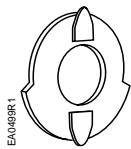

985-003
 Position indicators
 (10/pkg)

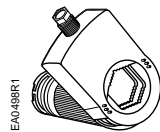

985-004
 Standard shaft adapter



985-006
 Anti-rotation (mounting)
 bracket



985-008
 Conduit adapter, 1/2-inch (12 mm)
 for 1/2-inch NPT connector.

Figure 12. Orderable Service Parts.

Operation

GCA12x and GCA22x: 2-Position Control

When power is applied, the actuator coupling moves toward the open position 90°.

GCA13x: 3-Position Control

A floating control signal controls the damper actuator. The actuator's angle of rotation is proportional to the length of time the signal is applied. A 24 Vac/dc control signal to Y1 causes the actuator coupling to rotate clockwise. A 24 Vac/dc control signal to Y2 causes the actuator coupling to rotate counterclockwise.

With no control voltage, the damper actuator holds its position.

GCA16x and GCA15x: Modulating Control

A continuous 0 to 10 Vdc or 2 to 10 Vdc signal from a controller to wire Y operates the damper actuator. The angle of rotation is proportional (or inverse proportional) to the control signal. A 0 to 10 Vdc, or 2 to 10 Vdc position feedback output signal is available between wires U and G0 (system neutral) to monitor the position of the damper actuator.

In the event of a power failure or when the operating voltage is shut off, all actuator models will return to the 0 position.

In the event of a blockage in a damper, actuators are overload protected over the full range to prevent damage to the actuators.

Life expectancy

An improperly tuned loop will cause excessive repositioning that will shorten the life of the actuator.

Implementation of DIP Switch Features (GCA15x Only)

| |
|--------------------|
| Counter Clockwise |
| Self-adapt feature |
| 2 to 10 Vdc |
| Tandem Mount |
| Master |

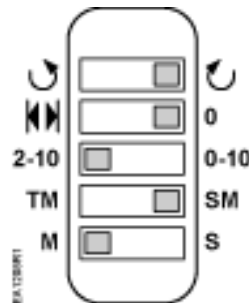

| |
|----------------|
| Clockwise |
| Self-Adapt Off |
| 0 to 10 Vdc |
| Single Mount |
| Slave |

Figure 13. GCA15x Series.

Control Signal Adjustment

GCA 163 and GCA164

The offset (start point) and span of the control signal can be adjusted. The offset, U_o , can be adjusted between 0 to 5 Vdc. The span, ΔU , can be adjusted between 2 to 30 Vdc.

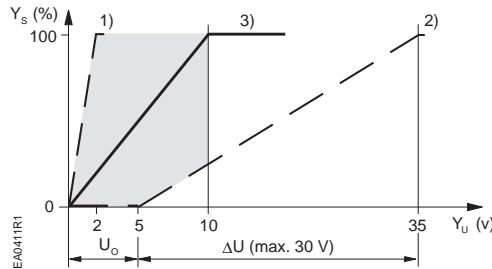

Y_s Mechanical positioning range (100% = angle of rotation 90°)
 Y_u Control signal
 U_o Offset (start point)
 ΔU Span
 $U_o = 0V, \Delta U = 2V$ The minimum working range for $Y_s = 100\%$

- $U_o = 5V, \Delta U = 30V$ The maximum working range for $Y_s = 100\%$
- $U_o = 0V, \Delta U \approx 10V$ Factory setting

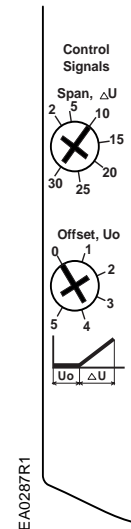

Setting for 10V span
 0V offset

Figure 14. The Minimum and Maximum Control Signal Adjustment.

Example:

Open the actuator from 0% to 50% (45°) using a control signal of $U_{min} = 2V$ to $U_{max} = 10V$.

Calculating the value of ΔU :

$$\Delta U = \frac{100 [\%](U_{max} - U_{min})}{\text{Working angle of rotation in } \%} = \frac{100 \times (10 - 2)}{50} = 16V$$

Settings

$U_o = 2V; \Delta U = 16V$

U_{min} = minimum control signal
 U_{max} = maximum control signal

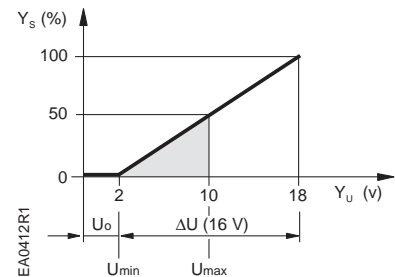
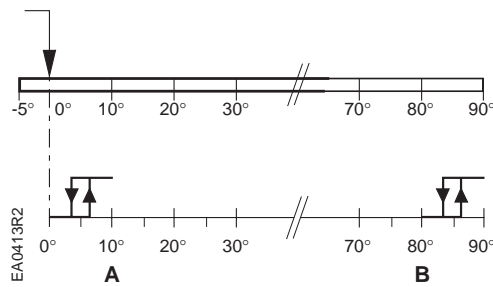

Figure 15. Example.

Dual Auxiliary Switch GCAxx4, GCAxx6



Actuator rotary range with the shaft adapter mounted at position "0".

Setting range for switches A and B

Setting interval: 5°

Switching hysteresis: 2°

To change the settings of A and B:

1. Make sure the actuator is in the "0", fail-safe position. The scale is valid only in the "0" position.
2. Use a flat-blade screwdriver to turn the switch adjustment dials to the desired setting at which a signal is to be given.

Factory setting:
 Switch A 5°
 Switch B 85°

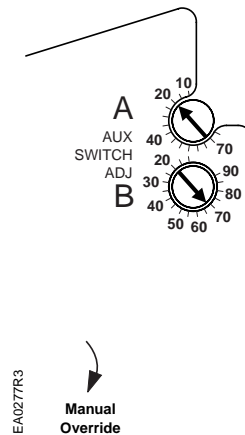

Figure 16. Dual Auxiliary Switch Dials.

NOTE: For GCA15x actuators with signal inversion switch set to Inverse Acting, 90° corresponds to either a 0 to 10 Vdc or a 2 to 10 Vdc. Vdc input signal depends on the input signal selection.

Sizing

The type of actuator required depends on several factors.

1. Obtain damper torque ratings (ft-lb/ft² or Nm/m²) from the damper manufacturer.
2. Determine the area of the damper.
3. Calculate the total torque required to move the damper:

$$\text{Total Torque} = \frac{\text{Torque Rating} \times \text{Damper Area}}{\text{SF}^1}$$

¹ Safety Factor: When calculating the total torque required, a safety factor should be included for unaccountable variables such as slight misalignments, aging of the damper, etc. A suggested safety factor is 0.80.

4. Select the actuator type using Table 2.

NOTE: Mechanically coupled actuators must all be of the exact same type except for the dual auxiliary switches and feedback potentiometer options. Make sure to use the correct tandem-mounting bracket. See Table 2.

| Table 2. | |
|--|--|
| Sizing | |
| Total Torque | Actuator |
| <62 lb-in (7 Nm) | GMA |
| >62 lb-in <142 lb-in (>7 Nm <16 Nm) | GCA |
| >142 lb-in <284 lb-in (>16 Nm <32 Nm) | ASK73.2U* : Tandem mounting bracket with any combination of GCA16x. ASK73.1U* : Tandem mounting bracket for all other GCAx actuators. |

NOTE: Used for tandem applications up to four actuators.*

Mounting and Installation

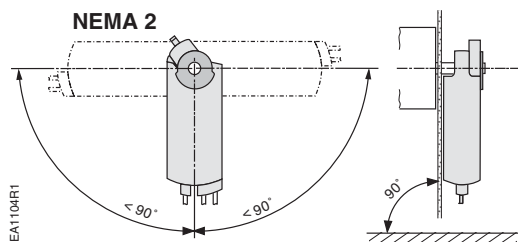

Figure 17.
Acceptable NEMA 2-Positions.

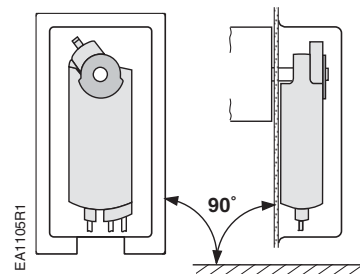

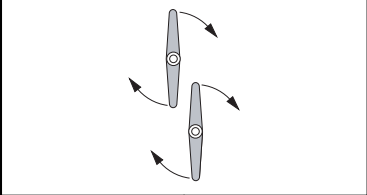
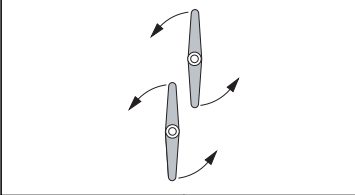
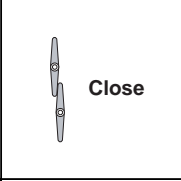
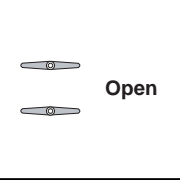
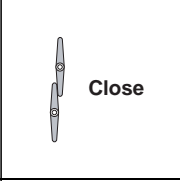
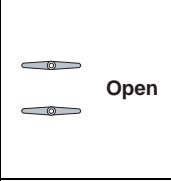
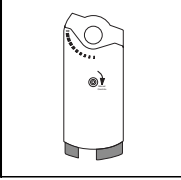
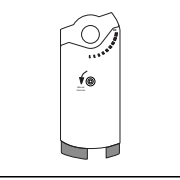
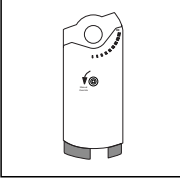
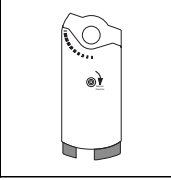
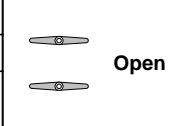
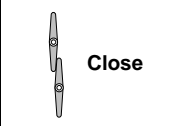
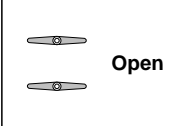
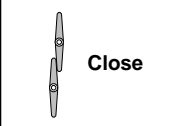
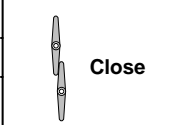
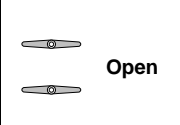
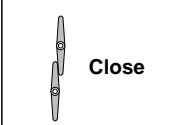
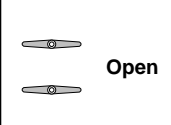
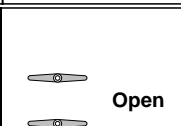
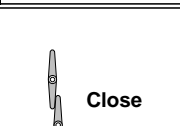
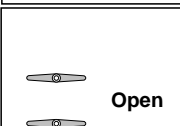
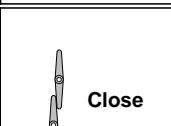
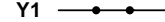
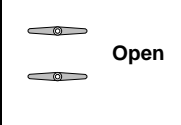
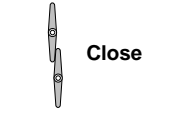
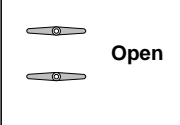
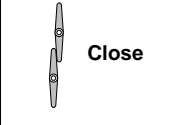
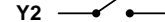
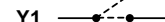
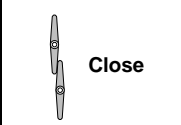
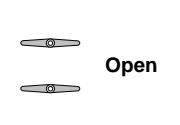
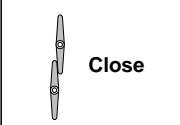
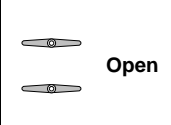

Figure 18.
Only Acceptable Position for NEMA Type 3R Rating Using ASK75.1U Weather Shield.

The GCA actuator is UL listed to meet NEMA Type 3R requirements (a degree of protection against rain, sleet, and damage from external ice formation) when installed with the Weather Shield (product number ASK75.1U) and outdoor-rated conduit fittings. Actuator must be in the vertical position.

- The shaft adapter and the position indicator can be mounted on either side of the actuator. The actuator mounting orientation and shaft length determine how they will be mounted on the actuator.
- The minimum damper drive shaft length is 3/4-inch (20 mm).
- See *Specifications* for the minimum and maximum damper shaft dimensions.
- The actuator is shipped from the factory with a 5° preload enabling tight close off of the damper in power-fail-close applications.
- A mounting bracket is included with the actuator.
- The shaft adapter and mounting parts are shipped in a separate container with the actuator.
- See the detailed mounting instructions included with each actuator.

Flip the actuator to select either clockwise or counterclockwise fail-safe rotation of the damper shaft. Follow steps 1, 2, and 3 of Table 3 to determine the correct actuator mounting orientation.

Table 3. Actuator Mounting Orientation and Damper Control.

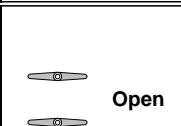
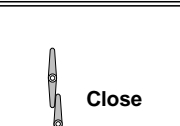
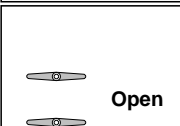
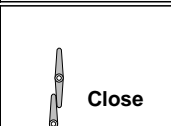
| | | | | | | | |
|----------|--|--|---|--|--|--|---|
| EA1037R2 | Determining the Actuator Mounting Orientation | ① Damper Type |  | |  | | |
| | | ② Power Fail Spring Return Position |  Close |  Open |  Close |  Open | |
| | | ③ Actuator Mounting Orientation |  |  |  |  | |
| EA1040R2 | Modulating Control | GCA15x Using 2 to 10 | Y = 10V Ω |  |  |  |  |
| | | | Y = 2V Ω | | | | |
| | | GCA15x or GCA16x Using 0 to 10 | Y = 10V (or Y = Uo + Δ U) |  |  |  |  |
| | | | Y = 2V Ω | | | | |
| | GCA15x or GCA16x Using 0 to 10 | Y = 10V Ω |  |  |  |  | |
| | | Y = 0V (or Y = Uo) | | | | | |
| EA1039R1 | 3-Position | GCA13x | Y1  |  |  |  |  |
| | | | Y2  | | | | |
| | | | Y1  |  |  |  |  |
| | | | Y2  | | | | |
| EA1038R1 | 2-Position | GCA12x | Power On |  |  |  |  |
| | | GCA22x | | | | | |

Manual override

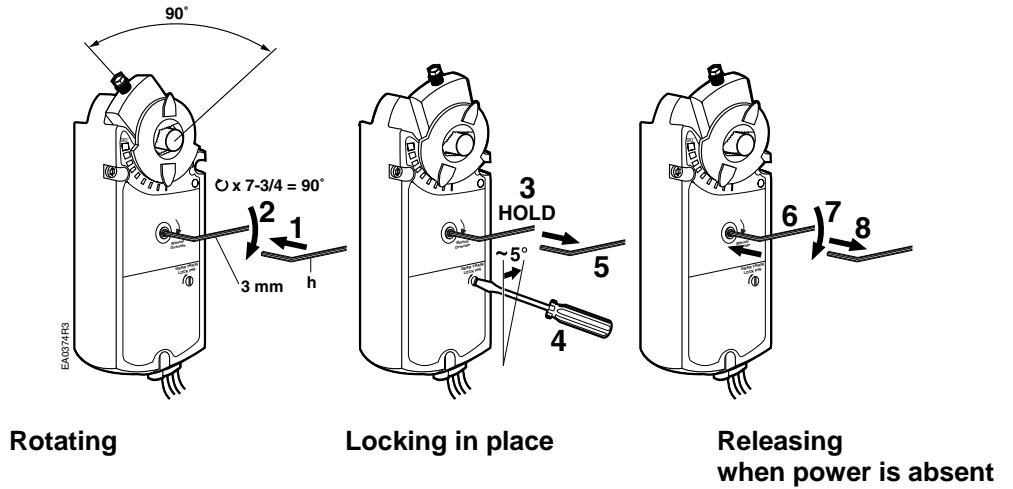

Figure 19. Manual Override.

Always turn the key in the direction of the arrow.



CAUTION:

When engaging the gear train lock pin, be careful to turn only about five degrees until you hear a click or meet slight resistance. Turning too far will strip the lock pin.

To release manual override, either restore power and send a control signal; or when power is absent, insert the 3 mm hex key in the override opening, turn the key in the direction of the arrow and remove the key.

Mechanical Range Adjustment

The angular rotation is adjustable between 0 and 90° at five-degree intervals. To limit the range of shaft movement, remove the locking clip and self-adjusting shaft adapter. Rotate the damper blade shaft to its failed position. Rotate the shaft coupling to the desired position. Insert the shaft adapter into the actuator and fasten it with the locking clip. See Figure 20.

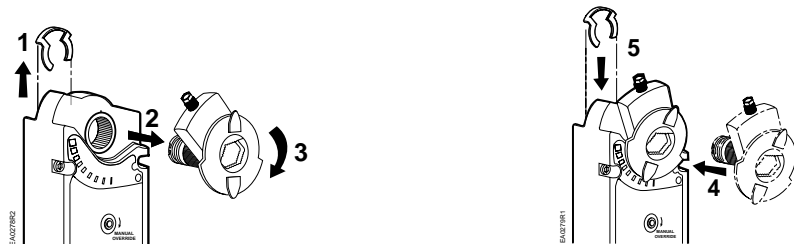

Figure 20. Mechanical Range Adjustment.

Wiring

All wiring must conform to NEC and local codes and regulations.

Use earth ground isolating step-down Class 2 transformers. Do not use autotransformers.

The maximum rating for a Class 2 step-down transformer is 100 VA. Determine the supply transformer rating by summing the VA ratings of all actuators and other components used. It is recommended that one transformer power not more than nine actuators (or 80% of its VA).



WARNING:

Mixed switch operation is not permitted to the switching outputs of both auxiliary switches (A and B).

Either AC line voltage from the same phase must be applied to all six outputs of the dual auxiliary switches, or UL-Class 2 voltage must be applied to all six outputs.

NOTE: With plenum cables, only UL-Class 2 voltage is permitted.

GCA15x.1x (0 to 10 Vdc or 2 to 10 Vdc) for Tandem Application (Master/Slave)

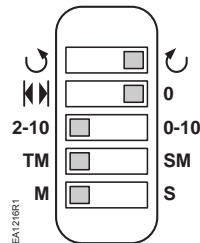

Figure 21. Tandem Application DIP Switch Settings.

- After setting the 4th DIP switch for TM (tandem mount) on all actuators used in the tandem application, one actuator must be identified as the Master by selecting the "M" on the 5th DIP switch.
- The rest of the actuators used in the application must have the "S" (slave) set on the 5th DIP switch.
- Connect all the 2 (black) Neutral wires and connect them to the power supply.
- Connect all the 1 (red) Supply wires together and connect them to the power supply.
- The Output Signal 9 (pink) wire, identified as the Master actuator, needs to be connected to all the Control Signal Wires 8 (gray) of the slave actuators used in the tandem application.

Wire Designations

Each wire has the standard symbol printed on it. See Table 4.

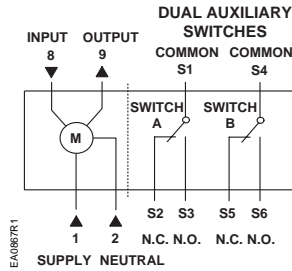

Figure 22. GCA15x, GCA16x, Modulating Control.

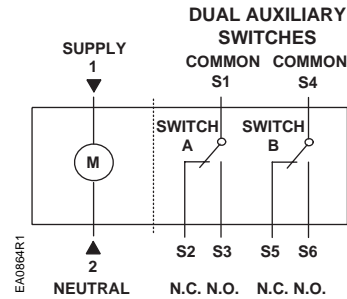

Figure 23. GCA12x, 2-Position Control.

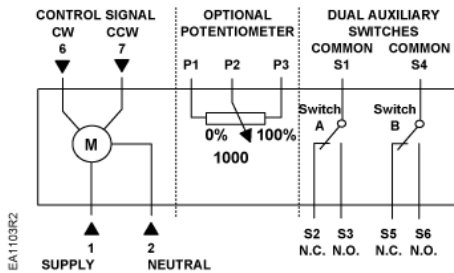

Figure 24. GCA13x, 3-Position Control.

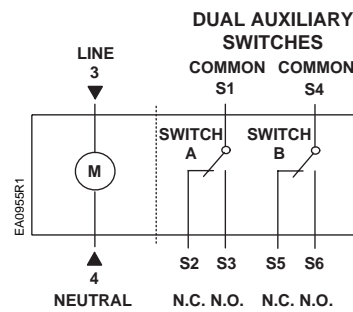

Figure 25. GCA22x, 2-Position Control.

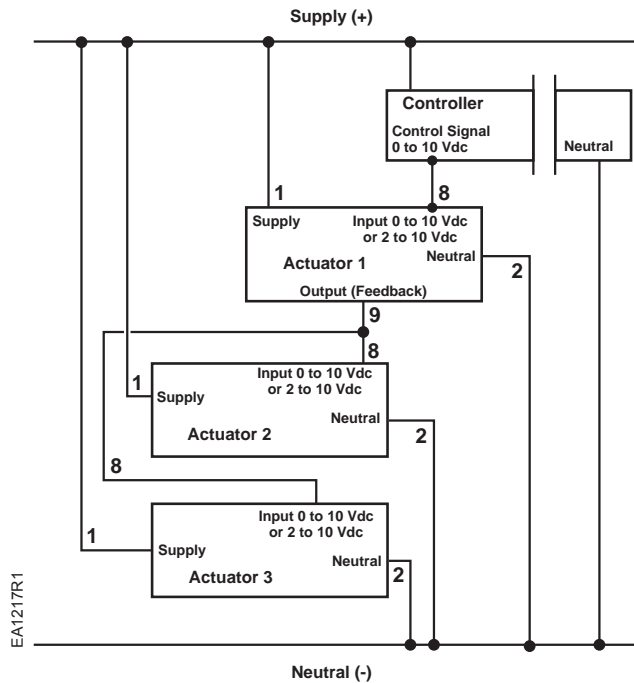

Figure 26. GCA15x.1x for Tandem Application (Master/Slave).

Table 4. Wire Designations.

| Standard Symbol | Function | Terminal Designations | Color | |
|-----------------|--|-----------------------|------------|------------|
| | | | Standard | Plenum |
| 1 | Supply (SP) | G | Red | Red |
| 2 | Neutral (SN) | G0 | Black | Black |
| 3 | Line (120 Vac) | L | Black | Black |
| 4 | Neutral (120 Vac) | N | White | White |
| 6 | Control Signal clockwise (GCA13x) | Y1 | Violet | Violet |
| 7 | Control Signal counterclockwise (GCA13x) | Y2 | Orange | Orange |
| 8 | Input signal: 0 to 10 Vdc (GCA16x) or 2 to 10 Vdc (GCA15x) | Y | Gray | Gray |
| 9 | Position output: 0 to 10 Vdc (GCA15x & GCA16x) | U | Pink | Pink |
| S1 | Switch A Common | Q11 | Gray/red | Gray/red |
| S2 | Switch A NC | Q12 | Gray/blue | Gray/blue |
| S3 | Switch A NO | Q14 | Gray/pink | Gray/pink |
| S4 | Switch B Common | Q21 | Black/red | Black/red |
| S5 | Switch B NC | Q22 | Black/blue | Black/blue |
| S6 | Switch B NO | Q24 | Black/pink | Black/pink |
| P1 | Feedback Potentiometer 0 to 100% P1 – P2 | A | White/red | Black |
| P2 | Feedback Potentiometer – Common | B | White/blue | Black |
| P3 | Feedback Potentiometer 100 to 0% P3 – P2 | C | White/pink | Black |

**Start-Up/
Commissioning
GCA12x (24 Vac)
GCA22x (120 Vac)**

1. Check Operation:
 - a. Switch on 24 Vac/dc power (or 120 Vac GCA22x).
 - b. Allow the actuator shaft coupling to rotate from 0 to 90°.
 - c. Switch off 24 Vac/dc power (or 120 Vac GCA22x).
The actuator shaft coupling will return to the "0" position.
 2. Check Spring Return:
 - a. Switch on 120 Vac power.
 - b. Allow the actuator shaft coupling to rotate halfway.
 - c. Switch off 120 Vac power.
The spring returns the actuator shaft coupling to the fail "0" position.
-
3. Check the Auxiliary Switch A:
 - a. Set the DMM dial to ohms (resistance) or continuity check.
 - b. Connect wires S1 and S3 to the DMM.
The DMM should indicate an open circuit or no resistance.
 - c. Switch on 120 Vac power.
The DMM should indicate contact closure as the actuator shaft coupling reaches the setting of switch A.
 - d. Connect wires S1 and S2 to the DMM.
The DMM should indicate open circuit or no resistance.
 - e. Switch off 120 Vac power.
The DMM should indicate contact closure as the actuator shaft coupling reaches the setting of switch A.
-
4. Check the Auxiliary Switch B:
 - a. Set the DMM dial to ohms (resistance) or continuity check.
 - b. Connect wires S4 and S6 to the DMM.
The DMM should indicate open circuit or no resistance.
 - c. Switch on 24 Vac power.
The DMM should indicate contact closure as the actuator shaft coupling reaches the setting of switch B.
 - d. Connect wires S4 and S5 to the DMM.
The DMM should indicate open circuit or no resistance.
 - e. Switch off 24 Vac power.
The DMM should indicate contact closure as the actuator shaft coupling reaches the setting of switch B.
-

**Start-Up/
Commissioning,
Continued —
GCA13x**

1. Check Operation:
 - a. Connect wires 1 (red) and 2 (black) to 24 Vdc power supply.
 - b. Apply a control signal (24 Vac/dc) to wire 6 (violet).
 - c. Allow the actuator shaft coupling to rotate from 0 to 90°.
 - d. Stop applying a control signal to wire 6 (violet).
 - e. Apply a control signal (24 Vac/dc) to wire 7 (orange).
 - f. Allow the actuator shaft coupling to rotate from 90 to 0°.

2. Check Spring Return:
 - a. Apply a control signal (24 Vac/dc) to wire 6 (violet).
 - b. Allow the actuator shaft coupling to rotate half way.
 - c. Disconnect wire 1 (red).
 - d. The spring returns the actuator shaft coupling to the fail "0" position.
 - e. Connect wire 1 (red). The actuator shaft coupling begins to move.

3. Check Feedback:
 - a. Set the digital multimeter (DMM) dial to ohms.
 - b. Connect wires P1 and P2 to the DMM. The DMM should indicate a resistive value.
 - c. Apply a control signal (24 Vac/dc) to wire 6 (violet).
The reading of the DMM should increase.
 - d. Stop applying a control signal to wire 6 (violet).
 - e. Connect wires P2 and P3 to the DMM. The DMM should indicate a resistive value.
 - f. Apply a control signal (24 Vac/dc) to wire 7 (orange).
The reading of the DMM should increase.

4. Check the Auxiliary Switch A:
 - a. Set the DMM dial to ohms (resistance) or continuity check.
 - b. Connect wires S1 and S3 to DMM. The DMM should indicate an open circuit or no resistance.
 - c. Apply a control signal (24 Vac/dc) to wire 6 (violet).
The DMM should indicate contact closure as the actuator shaft coupling reaches the setting of switch A.
 - d. Stop applying a control signal to wire 6 (violet).
 - e. Connect wires S1 and S2 to the DMM. The DMM should indicate an open circuit or no resistance.
 - f. Apply a control signal (24 Vac/dc) to wire 7 (orange).
The DMM should indicate contact closure as the actuator actuator-shaft coupling reaches the setting of switch A.

5. Check the Auxiliary Switch B:
 - a. Set the DMM dial to ohms (resistance) or continuity check.
 - b. Connect wires S4 and S6 to the DMM. The DMM should indicate an open circuit or no resistance.
 - c. Apply a control signal (24 Vac/dc) to wire 6 (violet).
The DMM should indicate contact closure as the actuator actuator-shaft coupling reaches the setting of switch B.
 - d. Stop applying a control signal to wire 6 (violet).
 - e. Connect wires S4 and S5 to the DMM. The DMM should indicate an open circuit or no resistance.
 - f. Apply a control signal (24 Vac/dc) to wire 7 (orange).
The DMM should indicate contact closure as the actuator actuator-shaft coupling reaches the setting of switch B.

**Start-Up/
Commissioning,
Continued—
GCA15x
GCA16x**

-
1. Check Operation:
 - a. Connect wires 1 (red) and 2 (black) to the 24 Vac or 24 Vdc power supply.
NOTE: With no input signal present, the GCA15x actuator with signal inversion switch set to Inverse Acting will start driving towards 90°.
 - b. Use a Digital Multimeter (DDM) and set the dial to Vdc for the actuator input signal.
 - c. Connect wires 2 (black) and 8 (gray) to the DMM.
 - d. Apply to input signal wire 8 (gray):
Y = 10 Vdc or Y = Uo + ΔU (GCA16x)
Y = 10 Vdc (GCA15x in direct-acting mode)
Y = 2 Vdc (GCA15x in inverse-acting mode)
 - e. Allow the actuator shaft coupling to rotate from 0 to 90.
 - f. Apply to input signal wire 8 (gray):
Y = 0 Vdc or Y = Uo (GCA16x)
Y = 2 Vdc (GCA15x in direct acting mode)
Y = 10 Vdc (GCA15x in inverse acting mode)
The shaft coupling returns to the "0" position.

 2. Check Spring Return:
 - a. Set the DMM dial to Vdc.
 - b. Connect wires 2 (black) and 8 (gray) to the DMM.
 - c. Apply to input signal wire 8 (gray):
Y = 5 Vdc or Y = Uo + 1/2 ΔU (GCA16x)
Y = 6 Vdc (GCA15x)
 - d. Allow the actuator shaft coupling to rotate halfway.
 - e. Disconnect wire 1 (red).
The spring returns the actuator shaft coupling to the fail "0" position.
 - f. Connect wire 1 (red) and the actuator moves.

 3. Check Feedback:
 - a. Set the DMM dial to Vdc.
 - b. Attach wires 2 (black) and 9 (pink) to the DMM.
 - c. Apply the input signal as in *Step 1d*, to wire 8 (gray).
The reading at the DMM should increase (decrease for GCA15x in inverse acting mode).
 - d. Apply the input signal as in *Step 1f*, to wire 8 (gray).
The reading at the DMM should decrease (increase for GCA15x in inverse acting mode) and the actuator shaft coupling returns to the fail "0" position.

 4. Check the Auxiliary Switch A:
 - a. Set the DMM dial to ohms (resistance) or continuity check.
 - b. Connect wires S1 and S3 to the DMM. The DMM should indicate open circuit or no resistance.
 - c. Apply the input signal as in *Step 1d*, to wire 8 (gray).
The DMM should indicate contact closure as the actuator shaft coupling reaches the setting of switch A.
 - d. Connect wires S1 and S2 to the DMM. The DMM should indicate open circuit or no resistance.
 - e. Apply the input signal as in *Step 1f*, to wire 8 (gray).
The DMM should indicate contact closure as the actuator shaft coupling reaches the setting of switch A.
-

**Start-Up
 Commissioning,
 GCA15X
 GCA16X
 Continued—**

5. Check the Auxiliary Switch B:
 - a. Set the DMM dial to ohms (resistance) or continuity check.
 - b. Connect wires S4 and S6 to the DMM. The DMM should indicate open circuit or no resistance.
 - c. Apply the input signal as in *Step 1d*, to wire 8 (gray).
 The DMM should indicate contact closure as the actuator shaft coupling reaches the setting of switch B.
 - d. Connect wires S4 and S5 to the DMM. The DMM should indicate open circuit or no resistance.
 - e. Apply the input signal as in *Step 1f*, to wire 8 (gray).
 The DMM should indicate contact closure as the actuator shaft coupling reaches the setting of switch B.

**Special
 Application**

Modulating 4 to 20 mA control with GCA15x and an external 499-ohm resistor (985-124, See *Accessories*).

NOTE: 985-124 is provided with the GCA15x actuator.

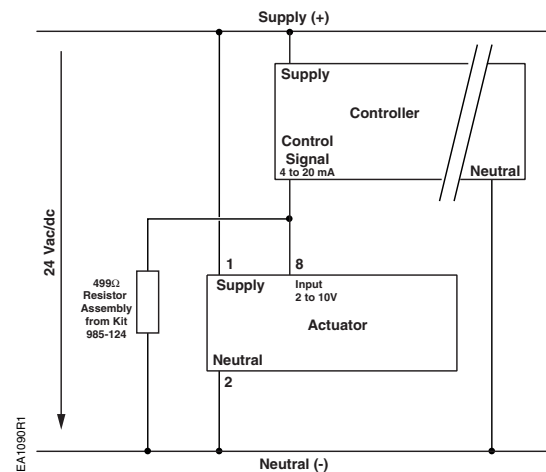

**Figure 27.
 Wiring Diagram for Converting
 4 to 20 mA into 2 to 10 Vdc.**

Service



WARNING:

Do not open the actuator. If the actuator is inoperative, replace the unit.

Troubleshooting



WARNING:

To avoid injury or loss of life, pay attention to any hazardous voltage (for example, 120 Vac) when performing checks.

- Check that wires are connected correctly.
- Check that offset (start point) and span are set correctly, if used.
- Use a Digital Multimeter (DMM) to verify that the operating voltage is within range.
- If the actuator is not working, check the damper for blockage. If blocked, remove the obstacle and cycle the actuator power off and on. The actuator should resume normal operating mode.

Dimensions

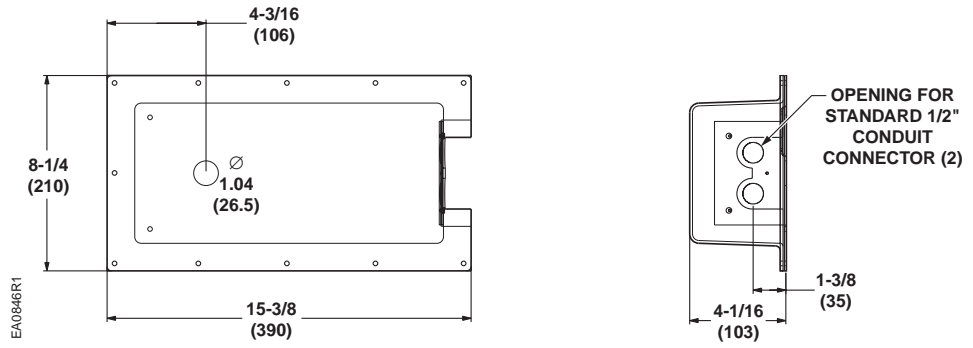

Figure 28. Dimensions of the ASK75.1U Weather Shield in Inches (Millimeters).

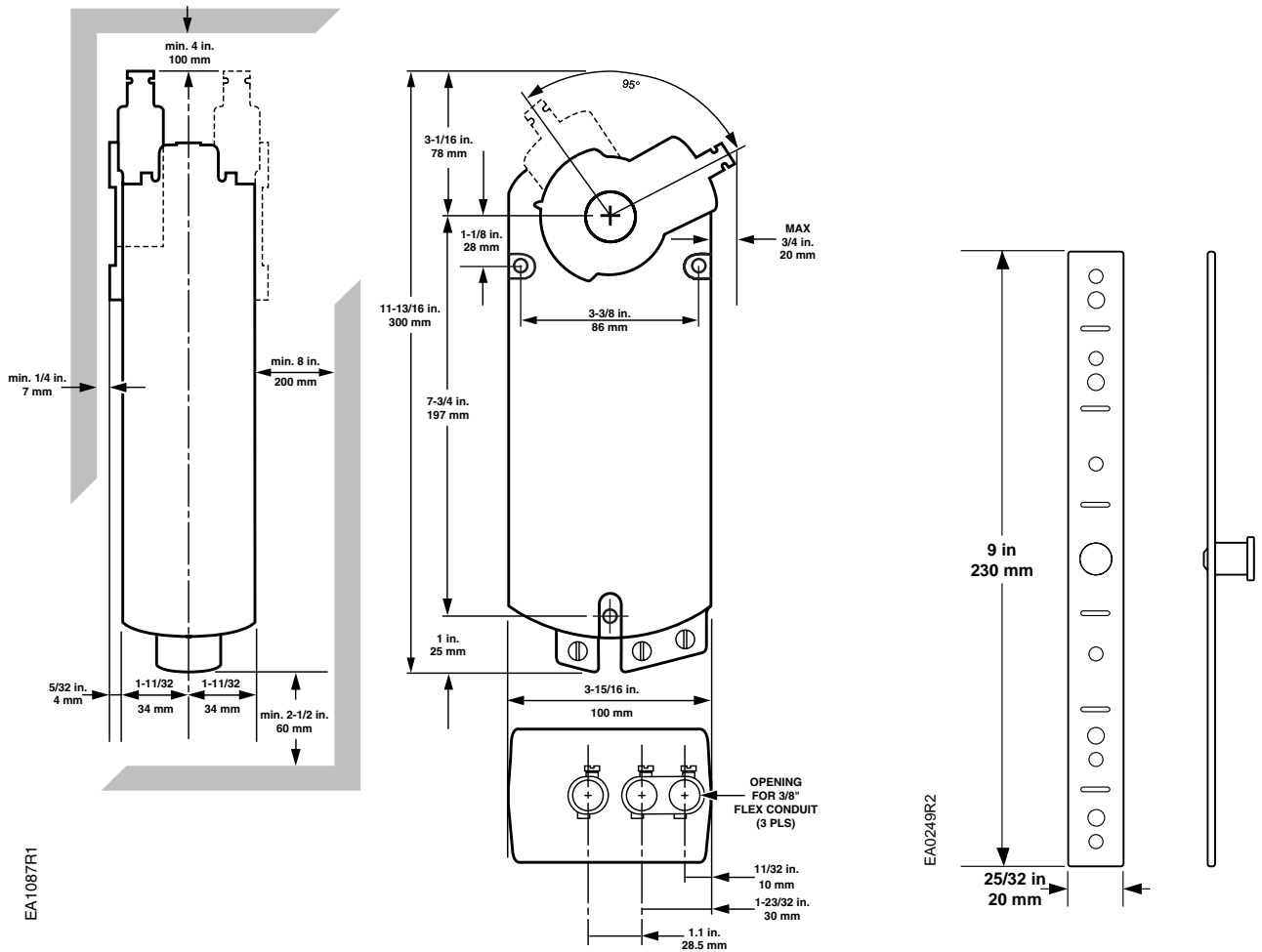

Figure 29. Dimensions of the GCA Actuator and Mounting Bracket in Inches (Millimeters).

Information in this publication is based on current specifications. The company reserves the right to make changes in specifications and models as design improvements are introduced. Other product or company names mentioned herein may be the trademarks of their respective owners. © 2006 Siemens Building Technologies, Inc.